

Rowenta

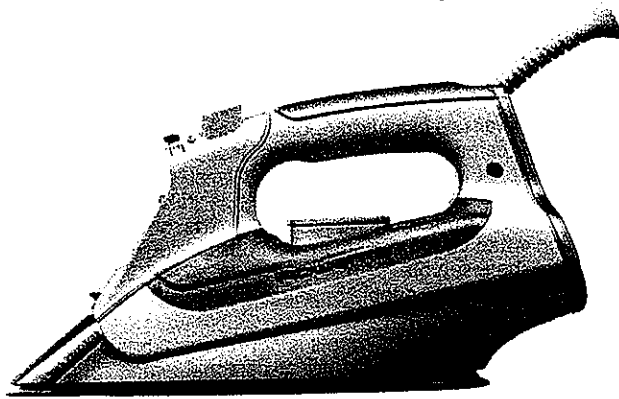

www.rowentausa.com

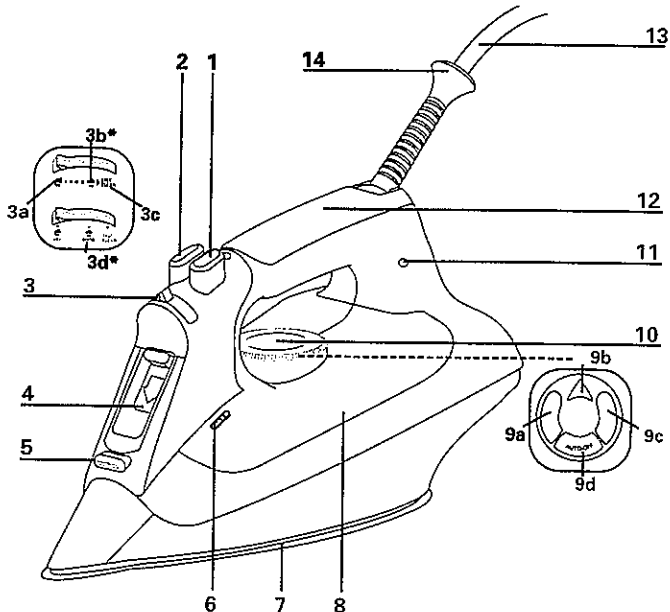

DESCRIPTION

- | | |
|---------------------------------|------------------------------|
| 1 Burst of steam button | 8 Water tank |
| 2 Spray button | 9 LED display* |
| 3 Variable steam control | a Yellow LED |
| a Dry ironing | b Green LED |
| b Steam ironing | c Red LED |
| c Self Clean | d Auto-off LED |
| d Autosteam * | 10 Temperature control dial |
| 4 Water Filling inlet | 11 Thermostat control light* |
| 5 Spray nozzle | 12 Handle |
| 6 Maximum water level indicator | 13 Cord |
| 7 Soleplate | 14 Cord support |
- * depending on model

IMPORTANT SAFETY INSTRUCTIONS

When using this appliance, basic safety precautions should always be followed including the following:

Read all instructions before using this product.

- Use appliance only for its intended use.
- To protect against a risk of electric shock, do not immerse the appliance in water or other liquids.
- The appliance should always be turned off before plugging or unplugging from outlet. Never yank the cord to disconnect from outlet, instead grasp plug and pull to disconnect.
- Always disconnect appliance from electrical outlet when filling with water or emptying or when not in use.
- Do not allow cord to touch hot surfaces. Let iron cool completely before putting away. Loop cord loosely around iron when storing.
- Do not operate appliance with a damaged cord or if appliance has been dropped or damaged.
- To avoid the risk of electric shock, do not disassemble the appliance. Ship it to the nearest authorized Rowenta approved service center for examination and repair. Incorrect reassembly can cause a risk of electric shock when the appliance is used.
- Not intended for use by children. Close supervision is necessary for any appliance being used near children. Unsupervised use can result in fire or personal injury. Do not leave appliance unattended while plugged in, on an ironing board, or while it is still hot.
- Burns can occur from touching hot metal parts, hot water or steam. Use caution when you turn a steam iron upside down. There may be hot water in the reservoir.
- Do not direct steam at people or animals or iron clothes while they are being worn.
- The use of accessory attachments is not recommended by Rowenta and may result in fire, electric shock or personal injury.

SPECIAL INSTRUCTIONS

- This is a 1600, 1700 or 1750 watt appliance. To avoid a circuit overload, do not operate a high wattage appliance on the same circuit.
- If an extension cord is absolutely necessary, the marked electrical rating should be at least as great as the electrical rating of the appliance. Cords rated for less amperage may overheat. Care should be taken to arrange the cord so that it cannot be pulled or tripped over unintentionally.
- Your Rowenta appliance is intended for household use only.

SAVE THESE INSTRUCTIONS

BEFORE USE

1 • Unpacking

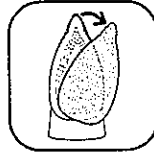

- Remove soleplate cover before using iron. Remove all packaging from the iron.
- Please read all of the instructions for use and the Important Safeguards carefully.
- It is normal for a small amount of smoke and a light odor to be produced the first time it is used. This will quickly disappear.
- Particles may emit from iron during first use. They are not harmful and should disappear after iron has been allowed to steam.

2 • Helpful Hints

- When ironing start with fabrics that require a low temperature setting (*) and finish with those which need the highest temperature (**).
- Mixed fiber fabrics should be ironed on the temperature for the most delicate fabric. For example a shirt that is 60% cotton and 40% polyester should be ironed at the (*) setting for synthetics.
- If spray starch is used, spray it onto the reverse side of the garment. Allow starch to penetrate before ironing by setting garment aside for 30 seconds.
- For best results, use a mesh type ironing board to allow excess steam to escape.
- For delicate fabrics, we recommend carrying out a test on an unobtrusive area of the garment such as an inner seam.
- Adhere to manufacturer recommendations on garment label.

WATER RECOMMENDATIONS

1 • Tap water

Rowenta irons are designed to be used with REGULAR TAP WATER (up to 12 grains of hardness). If your water is harder than this, Rowenta recommends mixing half tap water with half bottled spring water which reduces the hardness; or just use bottled spring water. Never use 100 % distilled water as this can cause the iron to spit and leak.

2 • Softened water

There are many types of household water softeners and the water from many of them is perfectly acceptable for use in an iron. However, some types of softeners, particularly those that use chemicals such as salt, can cause the appliance to leak or spit during use. If you experience this type of problem, we recommend that you try using bottled spring water or untreated tap water. Never use 100 % distilled water.

Once you have changed water it will take several uses to correct the problem. Rowenta recommends trying the steam function for the first time on an old towel or cloth that can be discarded to avoid damaging your clothes.

3 • Iron and other impurities

If your water supply contains large amounts of iron or organic matter, these minerals can collect inside the appliance and eventually appear as brown stains. If you experience these problems Rowenta recommends using bottled spring water. Never use 100 % pure distilled water.

ALWAYS REMEMBER: Battery water and water containing additives (such as starch, perfume or fabric conditioner condensed water from driers) may not be used. Such additives can affect the properties of the steam and, at high temperatures, can form deposits in the steam chamber, which will mark the laundry when they are emitted through the steam vents.
Descaling liquids/agents should not be used.

4 • Filling with Water



- Ensure the iron is unplugged.
 - Slide the variable steam control completely to the left.
 - Rest the iron on heel and tilt it forward approximately 1 inch.
- If the iron is equipped with a covered filling inlet, open the filling inlet by sliding the cover down.



- Fill with water (containing no additives) to the max mark on the water tank. We recommend using the enclosed filling cup rather than filling under the tap.

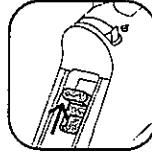

- If equipped with filling inlet cover, slide cover to close.

If you need to add water during ironing, UNPLUG the iron and follow the steps above. Ensure iron heats back to temperature afterwards, that means thermostat light will go out.

5 • Selecting the Temperature

The digital Temperature Control Dial allows you to closely monitor the temperature of the soleplate.

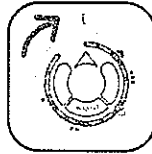

Set the temperature control dial according to the fabric you are ironing. Check the garment label for appropriate setting. We recommend using the chart below as a guide.

Ironing label	Fabric	Temperature control
	Synthetic fibers e.g. viscose, polyester	●
	Silk, wool	●●
	Cotton, linen	●●●

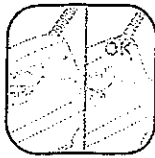

YELLOW LIGHT	The iron is heating up to reach the selected temperature.
GREEN LIGHT	The iron is ready to be used. The temperature of the soleplate reached the selected setting.
RED LIGHT	Do not iron. The temperature of the soleplate is too high for the selected setting.
AUTO-OFF	The Automatic Shut-Off has engaged. Move the iron gently to reactivate it.

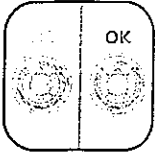

IMPORTANT! The iron takes longer to cool down than to heat up. We recommend that you start with fabrics to be ironed at a low temperature. For mixed fabrics set the temperature for the most delicate fabric.

TIP Always spray starch onto the reverse side of the fabric to be ironed.

6 • Dry Ironing

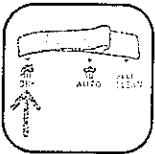

To iron without steam, slide the variable steam control lever to the **dry** position. We recommend dry ironing with an empty tank. Set the temperature for the type of material to be ironed.

7 • Steam Ironing

Steam is only produced when the temperature dial is set to the shaded area (after ****** setting)

WARNING! Never iron or steam clothes while they are being worn. Use caution and do not direct soleplate at people, animals, etc. Before ironing for the first time fill iron and allow to heat.

The iron should be allowed to emit steam for at least 1 minute to remove any impurities. Press the burst of steam button a few times prior to ironing. This should also be done if iron isn't used regularly.

8 • Auto Steam*

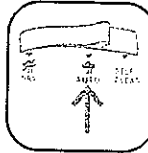

For steam output to be automatically adjusted to the soleplate temperature, turn the steam control to the **AUTO** position.

9 • Burst of Steam



This feature is ideal for removing stubborn wrinkles or pressing in sharp creases.

When the temperature control is set to a steam setting (****** or *******) the burst of steam can be used. Press the button to generate a burst of steam. Leave an interval of at least four seconds between bursts.

10 • Vertical Steam



This feature is ideal for hanging clothes, drapes, curtains, etc.

When the temperature control is set to a steam setting vertical steam can be used. To use feature, hold iron vertically with the tip tilted forward slightly. Press the burst of steam button repeatedly while moving iron up the garment from bottom to the top. If vertical steam output starts to decrease tilt iron forward to a horizontal position and then back to vertical to continue.

WARNING! Never direct steam at persons or animals.

* depending on model

11 • Spray Setting



This feature is ideal for stubborn wrinkles or set in creases. Ensure there is water in the tank then press the spray button.
Do not spray silk.

12 • Anti-Drip System*

In order to produce steam, all irons require a high temperature. If the soleplate is not hot enough some of the water will not turn to steam and can spit or leak from the soleplate. The Anti-Drip system automatically switches off the steam when ironing at low temperatures to prevent spitting.

13 • 3-Way Smart Automatic Shut-Off*

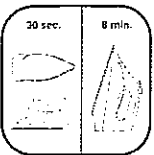

If your iron is equipped with Auto-Off and the iron is not moved while plugged in, an internal safety switch will turn it off. It will turn off in 8 minutes if left vertically or in 30 seconds if left on its soleplate or tipped over.

The white light on the LED temperature dial will flash when the Automatic Shut-Off feature has engaged. To deactivate feature, move the iron or shake it gently. Wait until the green light is on before ironing.

**AUTO-OFF IS NOT AN ON/OFF SWITCH.
ALWAYS UNPLUG WHEN NOT IN USE.**

14 • Self Clean

WARNING! Do not use descaling agents. They can damage the lining of the steam chamber.

This feature allows loose mineral deposits and other impurities to be flushed from the soleplate.

* depending on model

8

Self Clean should be carried out occasionally and at least once a month.

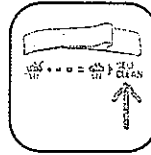

- Fill the iron with tap water to the max mark on the water tank.
- Be sure that variable steam lever is set to minimum.
- Stand the iron on heel and plug in.
- Set thermostat to (***) setting.
- Once heated, unplug iron.
- Hold iron horizontally over the sink with the soleplate pointing away from body.
- Move the variable steam lever completely to the right and hold in the self clean position for one minute.

WARNING! Doing this will cause steam and hot water to be ejected from the soleplate. Take all proper precautions and hold iron away from body.

- Move the iron gently back and forth and side to side until all water has run through plate.
- Carefully wipe all water and material from the soleplate with an old towel, as the water and minerals can stain the soleplate (although this has no effect on glide or performance).

WARNING! Iron and soleplate may still be very hot. Exercise care while wiping.

- Place iron on heel and leave to cool.
- Before using iron after self cleaning, test steam and burst of steam on an old towel or cloth that can be discarded.

15 • Vapodur Valve

To ensure the iron continues to steam efficiently, open and close the valve a few times after each use. This is done by moving the variable steam control lever left to right a few times.

* depending on model

9

16 • Anti-Calc System

- Minerals in water can build up in the steam chamber. The Anti-Calc system contains a special material that neutralizes the harmful minerals. This system is designed to extend and maintain the high steam performance of the iron. The cartridge is not replaceable.

NOTE: Do not use descaling agents in your iron.

17 • After Use

1. Turn the temperature dial to the min setting. Slide the steam lever to the no steam position.
2. Unplug the appliance.
3. Place the iron on its heel and allow to cool completely.
4. Empty water from the appliance before storing. We recommend emptying the iron when not in use.
5. To protect the soleplate, we recommend storing iron on its heel.

18 • Maintenance and Cleaning

Before cleaning ensure that the appliance is unplugged and completely cooled down.
Never use household cleaners, abrasive cleaning pads or solvents.

19 • Cleaning the Soleplate

Rowenta soleplates have excellent non-stick properties and can be wiped clean when cold.

- In normal use a draggy coating may build up on the soleplate (starch, detergent build-up, burnt synthetic fibers). This can be easily removed by using the Rowenta Soleplate Cleaning Kit or a quality hot iron soleplate cleaner available at most stores. The Rowenta kit is also available through our website: www.rowentausa.com

- To prevent scratching of the soleplate, do not iron over sharp objects (zippers, etc.). Do not place the iron on rough surfaces, e.g. metal iron support, which may scratch the soleplate.

20 • Troubleshooting

Issues	Possible causes	Solutions
Iron does not heat.	The temperature control is set too low. Not properly plugged in. Auto-off has engaged*.	Set the temperature control to a higher temperature. Check that iron is plugged in correctly. Move iron or shake it gently to reactivate.
Thermostat control light* or the yellow LED* goes on and off.	This is normal.	When the Thermostat control light* or the yellow LED* goes on and off the iron is heating up. As soon as the Thermostat control light* goes off or the green LED* lights up the set temperature has been reached.
Not enough steam.	There is insufficient water in the tank. Iron is not set to a steam setting. The Anti-Drip function is active*.	Fill the water tank. See section called "Steam Ironing". Wait for the soleplate to reach correct temperature.
Iron is emitting a brown or white substance.	Water may need to be changed due to hardness or organic matter. Garment has not been rinsed sufficiently.	See section "Water Recommendations". Switch to spring water or mix tap water with spring water. Ensure garment is rinsed thoroughly to remove any detergent deposits or chemicals on new garments.

Iron is leaking.	Over use of burst button. Distilled or softened water being used. Overfilled.	Allow more time between each burst. See section "Water Recommendations". Switch to spring water or mix tap water with spring water. Do not fill past max line on tank. Be sure to close filling inlet.
The Auto-off light is flashing	Auto-off has engaged*.	Move iron or shake gently to reactivate.
Build-up on the soleplate.	Starch use. Burnt material. Ironing at too high a temperature.	Spray reverse side of fabric and allow starch to penetrate. Be sure to set temperature according to fabric being ironed.
Spray function does not work.	Priming may be necessary on first use.	Fill with water. Hold cold iron horizontally. Place finger over the spray nozzle to create a vacuum. Press the spray button 4 to 5 times. Remove finger from nozzle, press spray button a few more times.

If troubleshooting does not assist, before consulting the retailer regarding their return/exchange policy, please telephone consumer service at 781-396-0600.

* depending on model

In the interest of improving products, Rowenta reserves the right to change specifications without prior notice.

LIMITED WARRANTY

This Rowenta product is warranted against defects in material and workmanship for one year from the initial purchase date. During this period any Rowenta product owned by the original purchaser that, upon inspection by Rowenta, is proved defective, will be repaired or replaced, at Rowenta's option, without charge to the customer. If a replacement product is sent, it will carry the remaining warranty of the original product. This warranty does not apply to any defect arising from a buyer's or user's misuse of the product, negligence, failure to follow Rowenta's instructions, use on current or voltage other than stamped on the product or alteration or repair not authorized by Rowenta. Repair or disassembly by anyone other than a Rowenta authorized service center will void the warranty. **THE WARRANTIES SET FORTH HERE IN ARE EXCLUSIVE AND NO OTHER WARRANTIES, EXPRESS OR IMPLIED, INCLUDING BUT NOT LIMITED TO ANY WARRANTY OF MERCHANTABILITY OR FITNESS FOR A PARTICULAR PURPOSE OR USE, ARE MADE BY ROWENTA OR ARE AUTHORIZED TO BE MADE WITH RESPECT TO THE PRODUCT. ROWENTA'S SOLE OBLIGATION IN THE EVENT OF A DEFECTIVE PRODUCT SHALL BE TO REPAIR OR REPLACE, AT ROWENTA'S SOLE DISCRETION, THE DEFECTIVE PRODUCT. IN NO EVENT SHALL ROWENTA BE LIABLE FOR ANY INDIRECT, SPECIAL, INCIDENTAL OR CONSEQUENTIAL LOSSES OR DAMAGES (INCLUDING BUT NOT LIMITED TO INTERRUPTION OF BUSINESS OR LOSS OF BUSINESS OR PROFIT) RESULTING FROM THE USE OF OR INABILITY TO USE THE PRODUCT, ANY BREACH OF WARRANTY OR ANY DEFECT IN THE PRODUCT EVEN IF ROWENTA SHALL HAVE BEEN ADVISED OF THE POSSIBILITY OF SUCH POTENTIAL LOSSES OR DAMAGES.** Some states do not allow limitation on how long an implied warranty lasts or do not allow the exclusion of incidental or consequential damages, so the above limitations may not apply to you. This warranty gives you specific legal rights, and you may also have other rights, which vary from state to state. If you believe your product is defective, bring the product (or send it, postage prepaid) along with proof of purchase to the nearest authorized Rowenta Service Center (see below). If you send the product, please include a letter explaining the nature of the claimed defect.

Rowenta
196 Boston Avenue
Medford, MA 02155
Tel.: (781)396-0600
www.rowentausa.com
OFFICE LOCATION ONLY.
To service product see service center information below.

If your appliance needs service, ship the product to your nearest regional service center. Be sure to put your name on the outside of shipping box (no P.O. boxes please). If in warranty, Rowenta will repair or replace product at their discretion. If the product is out of warranty, you will be advised of the cost of repair before any work begins.

Our main service centers are listed below:

Turnpike Appliance
3495A Lawson Blvd.
Oceanside, NY 11572
516-483-5596

Authorized Appliance
1644 West Ogden Ave.
Downers Grove, IL 60515
630-852-1550

Service center information is subject to change. Please visit our website at www.rowentausa.com or call our service center information line at 781-306-4620. The information line provides current service center information and listings in California.

Rowenta Werke GmbH, 63016 Offenbach am Main

212.110.348.1042 W&A